



Workbench Above-Worksurface Accessories Assembly Instructions

Assembly Instructions for:

- ① Backstops and Endstops
- ② Adjustable Riser Shelves
- ③ Stationary Riser Shelves
- ④ Instrument Riser Shelves

These instructions are designed to assist you in installing above worksurface accessories for Lista workbenches. Instructions for the complete workbench are included in the Workbench instruction booklet. Instructions for the Nexus Accessory Systems are included with the Nexus components.

Tools Required:

- Socket or Open End Wrenches with 3/8", 1/2" and 7/16" sockets, 3/8" drive with 3" to 6" extension
- #2 Phillips Head Screwdriver
- Flat Head Screwdriver
- Power or cordless drill
- #7 (.200" or 5.1mm) drill bit for pilot holes to accept 5/16" hex flange bolts
- 3/16" (.1875" or 4.8mm) drill bit for pilot holes to accept #14 slotted hex head lag bolts and #14 x 3/4" Phillips Pan Head screws
- Center Punch
- Measuring Tape

① Attaching Backstops and Endstops

Attaching the Endstops

- 1 Align the left Endstop flush with the bottom and rear edges of the worksurface.
- 2 Scribe pilot-hole locations for the Endstop's screw holes on the side of the worksurface and use a Center Punch to mark the precise center of the pilot hole.
- 3 Use a 3/16" drill bit to drill holes 3/16" dia. x 1" deep for each hole.
- 4 Mount the left Endstop with the #14 x 3/4" Phillips Pan Head screws.
- 5 Repeat the Steps 1 through 4 for the right Endstop.

Attaching the Backstops





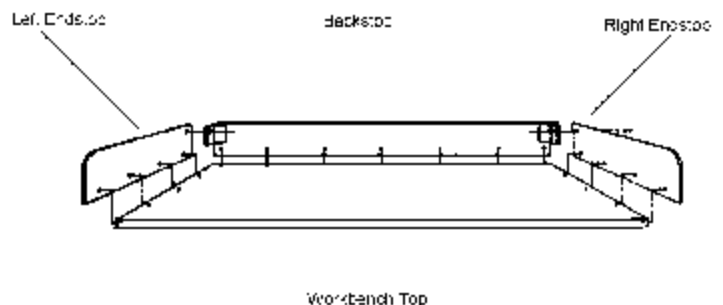

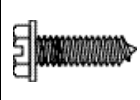
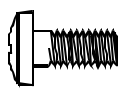

- 1 The Backstop has two 90° flanges. Bolt each flange to the Endstop using the two 1/4" - 20 x 1/2" Round Head screws and two 1/4" - 20 Kep nuts for each flange.
- 2 With the Backstop in place, drill pilot holes 3/16" dia. x 1" deep through the screw holes.
- 3 Secure the Backstop to the worksurface using the #14 x 3/4" Phillips Pan Head screws.

Note: If you are only attaching a Plain Backstop (with no Endstops or flanged edges), hold the Backstop flush with the bottom rear edge of the worksurface. Scribe pilot-holes and drill pilot holes 3/16" in diameter by 1" deep. Attach the Backstop using #14 x 3/4" Phillips Pan Head screws.

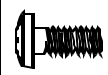

Hardware List

The following hardware is used for assembling the accessories shown in this manual.

	#14 x 3/4" Slotted Hex Head Screw			5/16" - 18 x 3/4" Phillips Pan Head Screw
	1/4" - 20 x 1/2" Phillips Head Round Screw w/ 1/4" - 20 Kep Nut			
			#14 x 3/4" Phillips Pan Head Screw	

② Attaching the Adjustable Riser Shelf

Note: If you are mounting the Adjustable Riser Shelf onto a butcher block worksurface, the edge of the Foot Mounting Plates must be a minimum of 1" from the edge of the butcher block worksurface. You should have two riser shelf supports for shelves up to 84" in length. You should have 3 supports for shelves over 84" in length. The capacity for butcher block and plastic riser shelves is 50 lbs. per linear foot.

Install Snap Button

- 1 Insert Snap Button ④ by squeezing the wide end together and inserting up into bottom of L-Bracket post ③ until the button snaps into the two holes in post.

Attaching the Foot Mounting Plates to the Worksurface

- 1 Place the Foot Mounting Plates ② on the worksurface at the desired location (approx. 12" from end of shelf).
- 2 Using the Foot Mounting Plates ② as templates, scribe two pilot-hole locations for each mounting plate. Mark the center of the holes with a Center Punch.
- 3 Remove the Foot Mounting Plates ② and drill the holes 1 1/4" deep using a #7 (.200" or 5.1mm) drill bit.
- 4 Place the Foot Mounting Plates ② onto the worksurface and align the hole patterns. Insert two 5/16" x 1 1/4" Hex Flange screws ⑤ through the Mounting Plates ② and into the worksurface to secure.

Attaching the Shelf to the L-Brackets

- 1 While holding in the Snap Button down ④, slide the two L-Brackets ③ down into the Foot Mounting Plates ②.
- 2 Place the Shelf ① on top of the L-Brackets ③ and mark the hole locations on the bottom of the Shelf ①. Use a Center Punch to mark the center of the pilot hole.
- 3 Remove the Shelf ① and place it upside down on your worksurface. Drill pilot holes 3/4" deep (two for each L-Bracket) into the Shelf ① using a 3/16" (.1875" or 4.8mm) drill bit.
- 4 Attach the Shelf ① to the L-Brackets ③ using two #14 slotted hex head screws ⑥ (two for each L-Bracket).
- 5 Depress both Snap Button ④ on each side of the Foot Mounting Plate and adjust to the desired height. The shelf should not have any weight on it prior to adjusting.

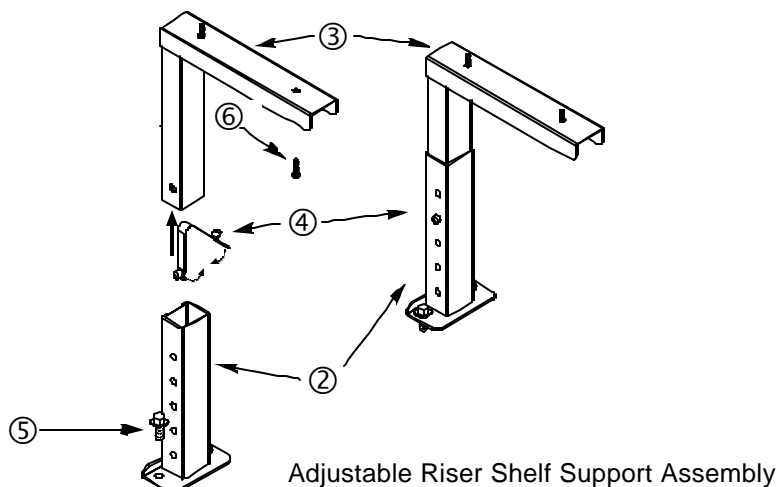

Components List

Item #	Description
①	Riser shelf (not shown)
②	Foot mounting plate
③	L Bracket
④	Snap-Button
⑤	5/16" x 1-1/4" Hex Flange screws
⑥	#14 x 3/4" hex head screw

③ Attaching the Stationary Riser Shelf

Listo provides two types of rear panels for the Stationary Riser Shelf: Partial and Full.

Assembling the Stationary Riser Shelf with a Partial Rear Panel

- 1 Place the Riser Shelf ① upside-down on worksurface.
- 2 Align the End Panels ② over the ends of the Riser Shelf ① and snap down into position. Rotate the assembly so that the back of the End Panels ② are facing up.
- 3 Place the Partial Rear Panel ③ with the tabs facing down, just below the Riser Shelf ①. Slide the Partial Rear Panel ③ into position until the two holes at each end are aligned. Secure the Partial Rear Panel ③ to the Riser Shelf ① and End Panels ② using $\frac{1}{4}$ " - 20 x $\frac{1}{2}$ " Phillips Head Round screws and $\frac{1}{4}$ " - 20 Kev nuts.

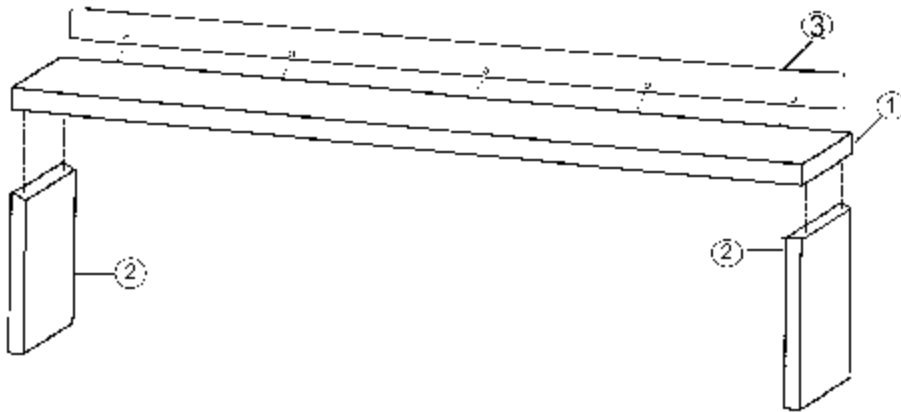

Stationary Riser Shelf (Partial Rear Panel)

Assembling the Stationary Riser Shelf with the Full Rear Panel

- 1 Lay the Full Rear Panel ① down (with the flange facing up) on your worksurface.
- 2 Place the Side Panel ② down on the Full Rear Panel ① so that the bottom rectangular cutout on the End Panel ② fits over the tab nearest the flange on the Full Rear Panel ①.

Note: When placing the End Panels onto the Full Rear Panel, make sure you have the correct End Panel. The Flat-finished sides of the End Panels should face the outside. All notches and holes should face the back.

- 3 Rotate the End Panel ② so that it is flush with the edge of the Full Rear Panel ①. Make sure the tabs of the Full Rear Panel ① fit into the slots of the End Panel ②. Repeat Steps 2 and 3 for the other End Panel ②.
- 4 Upright the Full Rear Panel ① with the End Panels ② attached on your worksurface.
- 5 Place the Shelf ③ over the End Panels ② and align the shelf's connector brackets so that they slide down and snap into the channels in the End Panels ②. Make sure the back of the shelf ③ fits securely into the tabs on the Full Rear Panel ①.

Attaching the Stationary Riser Shelf to the Workbench

- 1 Place the assembly onto the desired location of the worksurface. Scribe pilot hole locations through the two larger holes at the bottom of each bracket.
- 2 Move the assembly and drill pilot holes $\frac{3}{16}$ " in diameter by $\frac{1}{2}$ " deep.

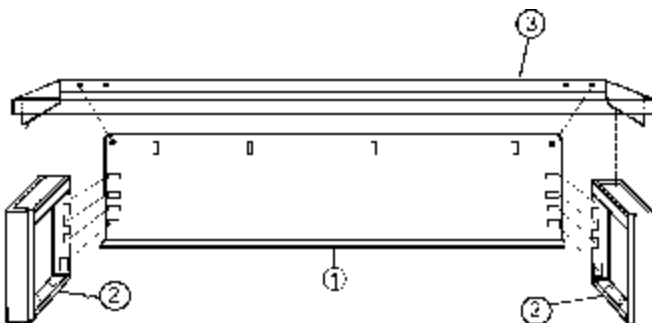

Stationary Riser Shelf (Full Rear Panel)

④ Attaching the Instrument Riser Shelf

If you purchased the Full Rear Panel option with the Instrument Riser Shelf, attach the Full Rear Panel first.

Attaching the Full Rear Panel (Optional)

- 1 Position the Full Rear Panel ① against the back of the worksurface so that the Tab ② rests on the worksurface. Scribe the hole locations. Remove the Full Rear Panel ① and mark the center of the scribed location with a Center Punch to ensure an exact center.
- 2 Drill holes 3/16" in diameter by 1" deep (using a 3/16" drill bit) through each scribed hole location.
- 3 Mount the Full Rear Panel to the workbench using #14 x 3/4" Phillips Pan Head screws.

Attaching the Instrument Riser Shelf Supports to the Worksurface

- 1 Remove the side panels ⑤ by unscrewing the #10 - 24 x 1/4" Phillips Head Round screws.
- 2 Place the Shelf Supports ④ onto the desired locations of the worksurface.

Note: If you have attached the optional Full Rear Panel ①, align the large diameter holes in the Full Rear Panel ① with the holes in the back of each Instrument Riser Shelf Support ④. The Tabs on the Full Rear Panel ① will align centered with the back of the Shelf Supports ④.

- 3 Scribe four pilot hole locations through the holes located on the bottom of each end of the Shelf Support ④.
- 3 Remove the Shelf Supports ④ and using a 3/16" drill bit, drill eight pilot holes 3/16" in diameter by 1" deep (four holes for each Support ④).
- 4 Replace the Shelf Supports ④ and secure each to the worksurface with #14 x 3/4" Slotted Hex Head screws.

Attaching the Instrument Riser Shelf to the Shelf Supports

- 1 Place the Shelf ③ onto the Shelf Supports ④ at the desired location.
- 2 From the inside top of each Shelf Support ④, locate and scribe four pilot-hole locations for each Support ④.
- 3 Remove the Shelf ③ and using a 3/16" drill bit, drill the pilot holes 3/16" in diameter by 1" deep for each.
- 4 Place the Shelf ③ onto the Shelf Supports ④ so that the hole patterns are aligned.
- 5 Secure the Shelf Supports ④ to the Shelf ③ using #14 x 3/4" Slotted Hex Head screws.
- 6 Replace the Side Panels ⑤ on each Shelf Support ④ with #10 - 24 x 1/4" Phillips Head Round screws.
- 7 Once Shelf ③ is installed, align the top row of holes in the Full Rear Panel ① with the back of the Shelf ③.
- 8 Drill holes 3/16" in diameter by 1" deep (using a 3/16" drill bit) through each scribed hole location.
- 9 Mount the Full Rear Panel ① to the worksurface using #14 x 3/4" Phillips Pan Head screws.

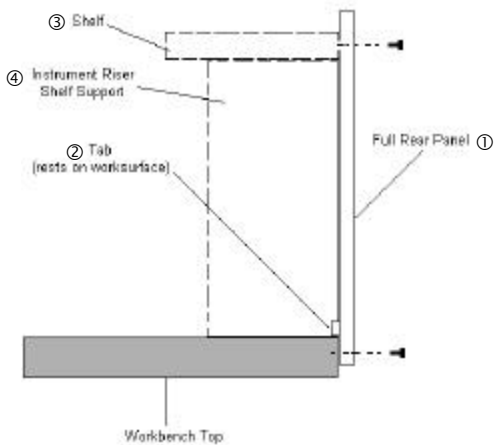

Instrument Riser Full Rear Panel
(optional)

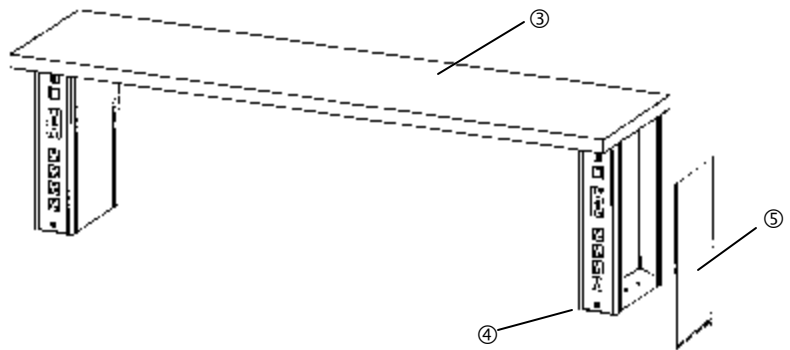

Instrument Riser Shelf Support Assembly

Document Number: MD014A3

Print Date: May 2006

For questions or Technical Support, call 1-800-722-3020, ext. 233 or 235.

© copyright 2006, all rights reserved.

Lista International Corporation

106 Lowland Street

Holliston, MA 01746